

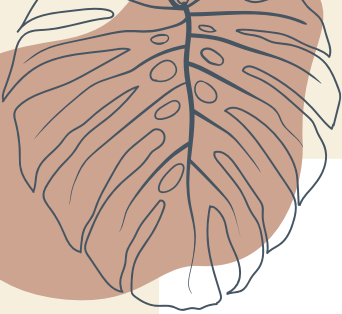

# EVENT SNAPSHOTS





## SESSION ON 'CHIPS FOR VIKSIT BHARAT'

Aligning with India's Semi-Conductor Mission and with an aim to strengthen the semiconductor facilities in India, Hon'ble Prime Minister Shri Narendra Modi laid down the foundation stone of three Semiconductor facilities. These facilities are: India's First Fab Facility in Dholera, Gujarat and Outsourced Assembly & Testing (OSAT) facilities in Sanand, Gujarat and Morigaon, Assam. The students, members of faculty and staff of IIT Bhubaneswar witnessed this programme through livestreaming.

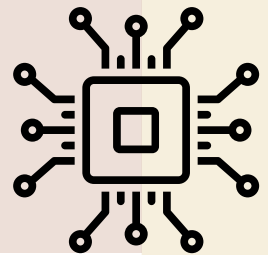
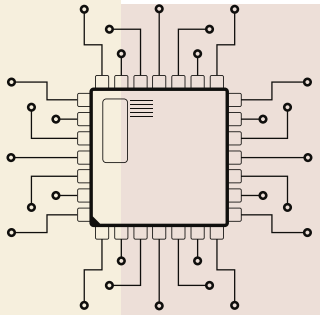

Speaking on this occasion, Prof. Shreepad Karmalkar, Director, IIT Bhubaneswar delivered a popular talk on the evolution and unique features of Semiconductor Technology. Mr. Manas Ranjan Panda, Special Secretary, Dept of Electronics & IT, Govt of Odisha spoke on the semiconductor initiatives in Odisha. Prof. P. V. Satyam from School of Basic Sciences spoke on the Semiconductor Eco-System in Bhubaneswar, and Dr. Vijay Shankar Pasupureddi, Associate Head (Electronics and Communication Engineering) presented the Semiconductor Activity at IIT Bhubaneswar.

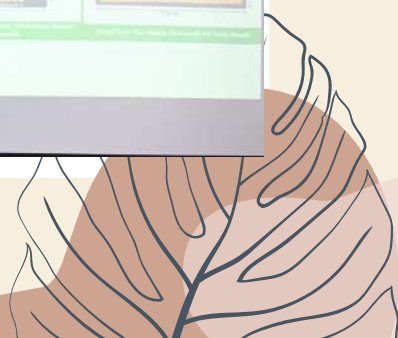
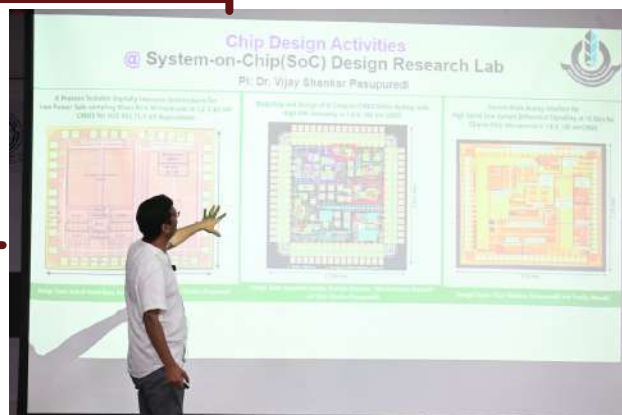

## WISSENAIRE 2024 EXPLORES SIGNIFICANCE OF DEFENSE TECHNOLOGY IN NATIONAL SECURITY



The Annual Techno-Management Festival Wissenaire 2024 was held from 8th to 10th March 2024. The theme of the year was 'PACEM STRIFE: The Significance of Defense technology as a deterrent to Aggression and to promote National Security.' Dr. Jagannath Nayak, the Director of the Centre for High Energy System and Sciences (CHES), DRDO graced the inaugural ceremony and spoke on the theme elaborately.

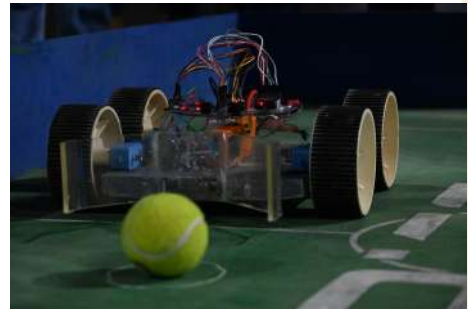

The fest featured cutting-edge exhibitions, workshops, robotics and drone competitions, providing a platform for tech enthusiasts to display their prowess and ingenuity.

The fest also had a bike show which was a feast to the eyes. Popular singer Dhvani Bhanushali enthralled the audience with her scintillating performance, during the closing ceremony.



## ENTREPRENEURSHIP & RURAL DEVELOPMENT CONCLAVE

IIT Bhubaneswar, in association with IIT Ropar and ERDC has organised Entrepreneurship & Rural Development Conclave 2024 on 11th and 12th March 2024. The inaugural session of the two-day programme was graced by Chief Guest, Hon'ble Governor of Jharkhand Shri C. P. Radhakrishnan Ji. The session was attended by over 140 participants, comprising school principals, college principals, gram panchayat heads, and NSS volunteers.



During the concluding ceremony, around 1000 NSS students from different professional and technical institutions and universities were administered with the oath of being job creators rather than being job seekers.



Prof. Shreepad Karmalkar, Director, IIT Bhubaneswar; Shri Chetan Sahore, National ERDC Head; Shri Amit Shukla, Founder EasyGov and Empower Panchayat; Smt. Sarita Patel, Regional Director, NSS; Shri Dayanidhi Urmaliya, National Advisory Board ERDC on Rural Entrepreneurship; Dr. Soobhankar Pathi, CEO, IIT Bhubaneswar Research Park; Prof. Sivaiah Bathula, NSS Coordinator, IIT Bhubaneswar and Dr. Nidhi Gautam Prabhakar, National Coordinator ERDC graced the occasion.



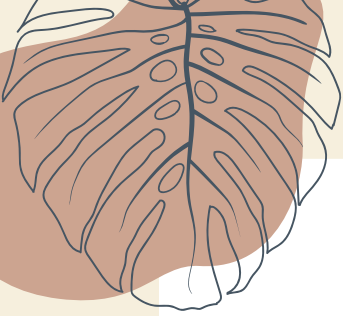

## SEMINAR ON COGNITIVE SCIENCE

A seminar on cognitive science was organised on 5th March 2024 on the theme 'What is cognitive science today? A current appraisal'. Prof Ramesh Kumar Mishra, University of Hyderabad spoke on the occasion and delved into an exploration of the dynamic and ever-evolving field of Cognitive Science.



The seminar provided the participants with a comprehensive journey through this dynamic field, covering diverse topics and offering a panoramic view. The seminar was organized by Dr. Aparna Pandey, Assistant Professor, (Psychology), School of Humanities, Social Science and Management.



## FIRST-EVER ASEAN RESEARCH SCHOLAR COMPLETES THESIS

As a remarkable mark in the field of research at IIT Bhubaneswar, Mr. Tran Dang Nhan, the first-ever Research Scholar of the institute in Doctoral Fellowship in India for ASEAN (DIA) programme of Ministry of Education, Govt of India, has recently defended his thesis. His thesis is titled "Estimation of Income and Price Elasticities of Electricity Demand in India". With this, he has now become the first alumni of the prestigious Doctoral Fellowship in India for ASEAN (DIA). He carried out his doctoral research under the guidance of Dr. Naresh Chandra Sahu, School of Humanities, Social Sciences and Management.



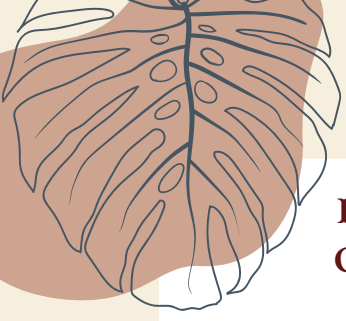

## HINDI WORKSHOP ON 'IMPORTANCE & MOTIVATION OF TRANSLATION INTO OFFICIAL LANGUAGE HINDI'

A successful Hindi workshop was conducted by the Official Language Unit of IIT Bhubaneswar on 5th March 2024 "Rajbhasha Hindi Mein Anuvad ka Mahtv aur Abhiprerna" ('Importance and motivation of translation into official language Hindi'). Members of faculty and staff of the institute actively participated in this workshop. The programme was presided over by the Shri Bamadev Acharya, Registrar, IIT Bhubaneswar. On this occasion, Shri Naveen Prajapati, Advisor and Center In-charge of Central Translation Bureau, Kolkata Centre, Government of India, graced the occasion as the guest speaker and shared his valuable thoughts with the participants.



# HAPPY READING!!!

